

DIAGNOSTICS

Overview 402

ETHOS® 404

SOLUS Ultra® 405

Vantage PRO™ 406

VERDICT™ 407

VERUS® 408

Accessories 410

Heavy Duty 422

Scan to learn about innovations in diagnostics from Snap-on

www.snapon.com/1200/diagnostics



YOU NEED ANSWERS SNAP-ON HAS THEM

Snap-on® diagnostic tools help you quickly get to the heart of complex problems

Platforms

From scan tools and oscilloscopes to internet capable multifunction tools, *Snap-on* diagnostics can help you manage the repair and your business

SCAN TOOLS – ETHOS® offers OEM specific coverage for dozens of systems on 40 makes, while SOLUS Ultra® also includes real-world troubleshooter tips and timesavers



OSCILLOSCOPE — Vantage PRO™ puts guided component tests in your hands, plus the accuracy of over 8 million data samples per second

MULTIFUNCTION TOOLS —VERDICT™ offers the freedom of Wi-Fi®, Windows®, a wireless scope, scan tool and display tablet. VERUS® also adds a big ten-inch display screen and 4-channel ignition test capabilities

Software and Accessories

The right software and accessories help you take advantage of all the power your diagnostic tools are designed to deliver

SOFTWARE UPGRADES — Snap-on offers regularly scheduled software upgrades with up-to-date information on today's vehicles

EUROPEAN SOFTWARE — Get the in-depth scanner coverage that is critical for servicing European makes

ACCESSORIES — From adaptors to secure storage to advanced testing tools, a comprehensive line of accessories will help match the tool to your work



DIAGNOSTICS

ETHOS® Scan Tool



EESC312 ETHOS Scan Tool. Gives VIN specific coverage that goes way beyond generic. First time users will love it for its straightforward operation, complete trouble code definitions and attractive price. Veteran users will love it for its lightning fast boot up and ability to quickly read and clear codes and graph live data.

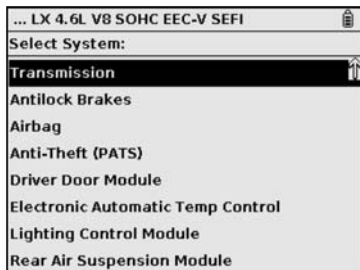

VIN specific codes and live data graphing for major vehicle systems.

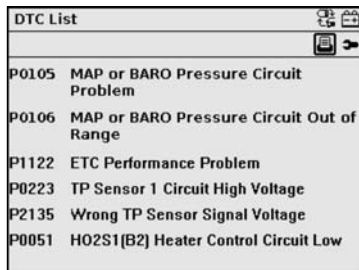

Read and clear OEM proprietary and global codes in just seconds with easy operation and simple code definitions.



Switch between English and Spanish language on the fly. Easy Y/N navigation saves time.

Features:

- 4.7" backlit monochrome display
- Fast 4 second boot up
- Easy year/make/model selection
- Bilingual (English and Spanish)
- Quick release protective display shield
- Graphs 4 live data parameters; or 9 parameters in digital mode
- User selectable hotkey for instant access to frequently used function
- Plug & play USB printing

- Store codes, screenshots and up to 230 frame movies for all data parameters
- Save and recall 20 previous vehicles
- 1983-later VIN specific codes and data for 33 U.S. and Asian makes*
- Deep coverage for dozens of systems: engine, transmission, hybrid control, transfer case, ABS, airbag, body, HVAC, instruments, TPMS, anti-theft and more
- Optional software for Audi®, BMW®, Land Rover®, Mercedes®, MINI®, Volkswagen®, SMART Car® and Volvo® vehicles

Includes:

- VIN specific U.S. and Asian software
- U.S. and Asian adaptor set, 1996 to current
- Hands on training video and user guide
- AC and DC power adaptors
- USB cable for PC connection
- 6 AA batteries

*Note: Some pre-1996 applications require optional adaptors



EESC318 SOLUS Ultra SCAN TOOL. Brings together a full range of scan tool functions, without any baggage to slow you down. No Personality Keys. No long boot ups. Combine that with the high resolution data graphing, detailed code definitions and OEM specific coverage and you have productivity and simplicity working together in perfect harmony.



Easy to read icons on big 7" display operate all functions from the 4 way keypad or the touch screen (even when wearing gloves).

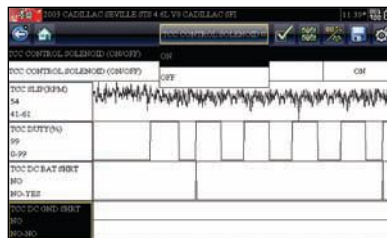

Powerful bidirectional tests. Control vehicle functions while viewing live data results on the screen.

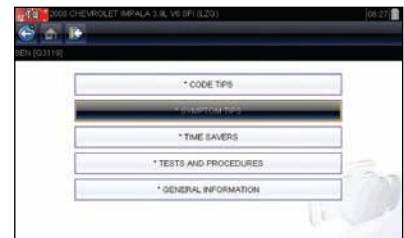

Exclusive Fast-Track® Troubleshooter provides expert code tips, symptom tips, tests and timesavers.

Features:

- Never stop to charge. "Steady charge" battery technology charges directly from vehicle
- Best in class display. Big 7" widescreen has 800 x 480 pixels; 50% larger than competitors
- Never change keys. A single, keyless adaptor covers all OBD-II applications
- Unique Cause and Effect Diagnostics. Control vehicle functions with bidirectional controls while viewing live data results on the screen
- Fast boot up. Ready to work in only 10 seconds
- Fast and easy icon navigation operates completely by touchscreen, or use the 4 way keypad and Y/N button
- Enhanced coverage for 1980-newer vehicles without the cost and complexity of factory scan tools
- Codes, live data (PIDS), functional tests, relearns, adaptations for 40 makes (European coverage optional)
- OEM specific coverage for dozens of vehicle systems, including the new systems techs need, like hybrids, TPMS, steering, body controls, EVAP, clean diesels and more

- *Fast-Track* Troubleshooter provides experience based fast fixes to get through repairs quickly. Real world advice from technicians, including code tips, symptom tips, tests and timesavers
- Read and clear trouble codes; Display detailed trouble code descriptions on screen
- Graph from 1 to 4 live data parameters (PIDs) simultaneously; view up to 7 data parameters in text mode
- Print/save/share/view results on PC via ShopStream™ Connect software
- Custom controls: user programmable shortcut key, PID trigger, zoom, freeze frame, custom data list, screen capture, movies and cursor functions
- Powerful functional tests and bidirectional controls provide control of vehicle systems for repair validation and a confident diagnosis

Includes:

- SOLUS Ultra scan tool
- Upgradable software on microSD card
- Keyless data cable for all OBD-II vehicle applications
- Li-ion battery pack
- 110 V AC power adaptor and cord
- USB cable for PC connection
- Custom fit blow molded carrying case
- Safety instructions; Quick start guide; User manual on CD

Note: Some applications require optional adaptors.



WARNING



- Do not use in environment with explosive vapor
- Read safety precaution on pages W1 to W4

DIAGNOSTICS

Vantage PRO™ Power Graphing Meter



EETM303 Vantage PRO Meter. Unparalleled component diagnostics with a high speed scope and graphing multimeter. Get the answers needed for confident diagnosis including 2 million component tests, and 8 million samples per second of data. Compare live readings with known good data and sample waveforms. Simply select the vehicle and component and *Vantage PRO* will configure the meter and guide user through the test.

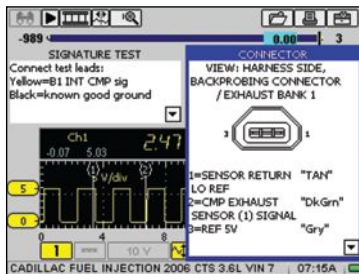

Graphing meter and advanced scope based test information for over 2 million components.

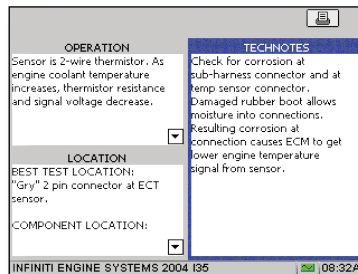

Guided test procedures include connector locations, component operations, meter presets, common faults and expected values.

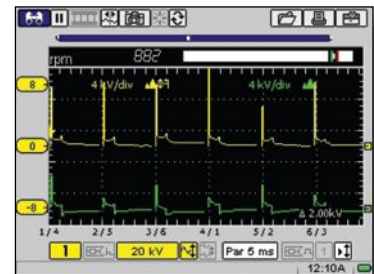

Lab scope, ignition scope and graphing multimeter allow you to test everything from sensors to multicylinder ignition.

Features:

- Big 5.7" backlit color display is easy to read
- Removable high power NiMH battery for over 5 hours continuous use
- Fast boot; ready to go in 10 seconds
- Store over 1,000 screens of data
- Up to 57 hours of continuous recording
- Peak detect clearly displays glitches and dropouts other scopes miss

Component Test Information:

- Component database for 40 U.S., Asian and European makes, 1979 to current
- Navigate by year/make/model or select a specific component or system
- Coverage for sensors, solenoids, ignition, injectors and much more

- Tips and tutorials including component locator, test procedures, connection diagrams, presets and reference values
- Waveform Library; compare live data with known good values

2-Channel Lab Scope and Ignition Scope:

- Sample rate 8 megasamples/sec/channel; Bandwidth 3 MHz; Scales 0-100 mV to 0-200 V, 50 kV secondary ignition; plus dedicated shunt amps channel
- Sweep rate 50 microseconds to 20 seconds
- Secondary ignition scope with single/multicylinder, raster, parade and superimposed views (multicylinder adaptors optional)

Digital/Graphing Volt-Ohm Meter:

- Auto scaling; 0-100 mV to 0-400 V scales, 0-100 mA to 0-10 A scales; 10 Megohm high impedance, 50 mS glitch capture, min/max capture
- DC volts, AC volts, amps, ohms, duty cycle, frequency, pulse width
- Sweep rates from 1 sec to 5 min

Includes:

- Component database for U.S., Asian, European makes
- 2 shielded scope leads, 2 insulated alligator clips and 2 probe tips
- Hands on training video and user guide
- Protective carrying case
- Rechargeable NiMH battery pack
- Battery charging station
- AC power adaptor

VERDICT™ Modular Diagnostic & Information System



EEMS324 VERDICT Diagnostic System. Includes a wireless display, scanner and meter to let you be in more places at once. View all of your readings and control the scanner and scope remotely from the display. Have everything you want, use only what you need.



High resolution display shows detailed graphing of up to 12 data parameters for precise results.



Wireless Component Test Meter features automatic presets, guided test procedures and known good values and waveforms.

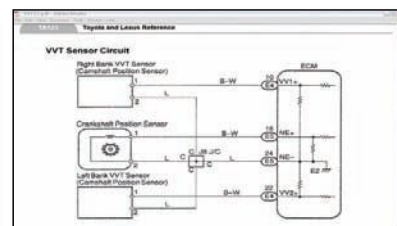

Hotlinks to Fast-Track® reference material including valuable TSBs, component locator and wiring diagrams.

Features:

- Wireless display, scanner and meter lets technicians be in more places at once
- Real world answers in your hands from anywhere in the shop: codes, live data, bi-directional controls, *Fast-Track* guided component tests, Internet and Troubleshooter
- OEM specific scanner coverage for 1980-newer vehicles
- High speed 2 channel scope and graphing meter
- Keyless scanner module for quick, simple connection
- Wi-Fi® and Internet browser to access web resources
- Windows® operating system
- Internal hard drive
- Touch screen operation

VERDICT D7 Display

Tablet Features:

- Big, bright 7" color touchscreen
- Windows multitasking
- Internet browser and Wi-Fi
- Wireless: Long-range Class 1 Bluetooth®
- 1 touch navigation shortcuts
- 60 GB internal hard drive
- Built-in 2 mega pixel camera
- Li-ion battery pack for up to 4 hours of continuous operation

VERDICT S3 Scanner

Module Features:

- Wireless remote control from the VERDICT D7 Display Tablet
- Keyless adaptor for OBD-II applications
- OEM specific coverage for 40 makes (European optional)
- *Fast-Track* Troubleshooter code tips, symptom tips and repair timesavers
- *Fast-Track* database of reference values, TSBs, wiring diagrams and more
- View up to 12 live data graphs at once

VERDICT M2 Scope/Meter

Module Features:

- High speed 2 channel lab scope and digital/graphing meter
- *Fast-Track* guided component tests for 40 U.S., Asian and European models
- Use alone or by wireless remote control from display tablet
- 20 megasamples/sec on each channel
- Scale range: 0-100 mV to 0-1000 V DC
- Sweep rate: 50 microseconds to 20 seconds. Up to 60 minutes in meter mode
- 2 MHz bandwidth
- 1/4 V A full color display
- High speed glitch capture
- 10 Megohm high impedance meter
- V DC, V AC, ohms, continuity, frequency, capacitance, duty cycle, pulse width and diode test
- CATIII and CATIV certified to 1,000 V
- NiMH battery pack for up to 12 hours continuous operation

Note: Some applications require optional adaptors.



WARNING



- Do not use in environment with explosive vapor
- Read safety precaution on pages W1 to W4

DIAGNOSTICS

VERUS® Wireless Diagnostic & Information System



EEMS325

EEMS323 VERUS Wireless and Information System. Puts the answers you need at your fingertips, to manage the complete job from start to finish. With true Windows® multitasking, Wi-Fi® and an internet browser, you won't have to leave the service bay to access technical forums, OEM websites, online parts suppliers or the optional ShopKey® repair information system.

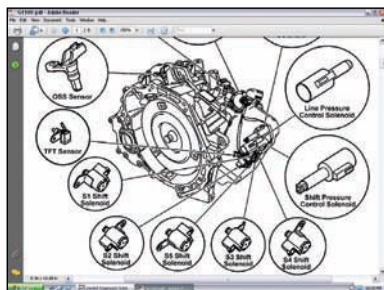

Complete *Fast-Track* Troubleshooter and quick links to the onboard reference database.

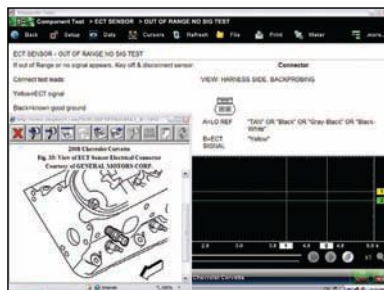

Windows XP® multitasking provides the flexibility to use and view several tools at once.



Direct links take you from the scan tool function to the integrated *ShopKey* Repair Information System (*ShopKey* subscription optional).

Features:

- 10.4" high resolution X A 1024 x 768 touchscreen color display
- Save time with one click shortcuts to diagnostic applications
- Replaceable Li-ion battery pack for up to 4 hours of continuous power
- 802.11b/g Wi-Fi and web browser
- Connectivity and expandable storage; V A, LAN, AUX, audio and USB ports
- Big 250 B hard drive to store test results, vehicle records and software applications

Scanner:

- Freedom to scan from anywhere in the bay with wireless scan module
- Custom data lists, freeze frame, PID sorting, pause, zoom, PID trigger, snapshot and cursor functions
- raph 16 live data parameters; or view up to 50 in digital mode
- Detailed code definitions, live data, functional tests, and relearns/adaptations
- OEM specific vehicle communication for 1980-newer models

- Optional coverage for European makes Audi®, BMW®, Land Rover®, MINI®, Mercedes®, SMART®, Volvo® and VW® vehicles

Component Test Information:

- Component database for 40 U.S., Asian and European makes, 1979-current
- uided diagnostics including component locator, test procedures, connection diagrams, presets and reference values
- Coverage for sensors, solenoids, ignition, injectors and much more
- Waveform Library compares live readings with known good values

4-Channel Lab Scope and Ignition Scope:

- Automatic scaling, presets and custom configurations for easy setup
- Sample rate 6 megasamples/sec; Bandwidth 3 MHz; scales 0-100 mV to 0-400 V, 50 KV secondary ignition
- Sweep rate 50 microseconds to 20 seconds
- Secondary ignition scope (multicylinder ignition adaptors optional)

Digital/Graphing Volt-Ohm Meter:

- Auto scaling; 0-100 mV to 0-400 V scales, 0-100 mA to 0-10 A scales; 10 Megohm high impedance, 50 mS glitch capture, min/max capture
- DC volts, AC volts, amps, ohms, duty cycle, frequency, pulse width
- Amps, vacuum, pressure functions (probes optional)
- Sweep rates from 1 second to 5 minutes

Includes:

- VIN specific U.S. and Asian Software
- U.S. and Asian adaptor set, 1996 to current
- 4 shielded scope leads, clips
- Hands on training video and user guide
- Protective carrying case
- Rechargeable Li-ion battery pack
- AC power adaptor

Note: Some applications require optional adaptors.

	Vantage PRO™	ETHOS®	SOLUS Ultra®	VERDICT™	VERUS® Wireless
					
	EETM303	EESC312	EESC318	EEMS324	EEMS325
Touchscreen Operation			X	X	X
10" Color Backlit Display					X
7" Color Backlit Display			X	X	
5.7" Color Backlit Display	X				
4.7" Monochrome Backlit Display		X			
Reads and Clears Codes & Data		X	X	X	X
Live Data Graphing Display		X	X	X	X
Functional Tests/Bidirectional Controls			X	X	X
Relearns & Initializations			X	X	X
Fast-Track Troubleshooter			X	X	X
Keyless Scanner Adapter			X	X	X
Wireless Scanner				X	X
2 Channel High Speed Oscilloscope	X			X	
4 Channel High Speed Oscilloscope					X
Ignition Scope	X				X
Graphing/Digital Multimeter	X			X	X
Wireless Scope/Meter				X	X
Bilingual (English/Spanish)		X			
High Capacity Internal Hard Drive				X	X
USB Port	X	X	X	X	X
Wi-Fi Enabled & Internet Browser				X	X
High-Energy Rechargeable Battery	X		X	X	X
Windows Operating System				X	X
Fast-Track Guided Component Tests (U.S., Asian and European)	X			X	X
OEM Specific 1980-newer U.S. Scanner Coverage		X	X	X	X
OEM Specific 1983-newer Asian Scanner Coverage		X	X	X	X
OEM Specific European Scanner Coverage		0	0	0	0
Global OBD-II Coverage for all Makes		X	X	X	X
User Programmable Function Key	X	X	X	X	X
ShopKey Repair Information System				0	0
ShopKey Manager SE Viewer				0	0

X = Standard Equipment 0 = Optional



WARNING



- Do not use in environment with explosive vapor
- Read safety precaution on pages W1 to W4

Accessories

VERUS®



EAK0294B21A VERUS Wireless Conversion Kit.

- Wireless Scan Module adds wireless freedom and keyless simplicity to EEMS323 Diagnostic and Information System
- Simplicity, no more searching for keys. Keyless scan module covers OBD-II applications with a single adaptor
- Scan wirelessly with remote control of the Scan Module; set codes, live data, functional tests, relearns and adaptations while moving freely around the vehicle
- Includes: Wireless scan module, OBD-II data cable, data cable for adaptors, USB cable and instructions
- Note: Requires VERUS diagnostic unit with Software Bundle 10.4 or higher



EAA0354L40A Velcro® Handgrip.

- Secure, adjustable Velcro strap makes it easy to hold VERUS diagnostic unit with one hand. (VERUS shown not included)



Silicone Protective Skins.

- Personalize and protect your VERUS diagnostic unit in choice of colors
- Custom fit, nonslip silicone rubber protective skin keeps VERUS diagnostic unit clean and safe

EAC0101L70A1 - Black
 EAC0101L70A2 - Blue
 EAC0101L70A3 - Red
 (VERUS shown not included)



Stylus (3 pack).

- High polished chrome stylus or durable black nylon stylus
 - Soft tip to protect touchscreen
- 3-06206A01 - Nylon
 3-07406A01 - Chrome



EAK0294B02A Charging Station with USB Hub.

- Secure benchtop workstation for VERUS diagnostic unit
- Charges VERUS battery when used with standard VERUS power adaptor
- Internal USB hub joins up to 4 USB devices when connected to VERUS diagnostic unit with standard USB cable (included). (VERUS shown not included)



EAE0059L07A External Battery Charger.

- Smart charger for up to 2 VERUS battery packs
- Automatic fast charge and trickle mode
- Includes 110 V AC power supply



EAA0354L12A VERUS Battery Pack.

- Keep a diagnostic tool on duty all day long with a spare high energy Li-ion battery
- Built in LEDs show charge status



2-02539A 110 V AC Power Supply.

- Powers VERUS diagnostic unit and quick charges battery pack
- Requires 6-06321A power cord



6-06321 AC cord for 110 V Power Supply.

- Line cord for AC power adaptor

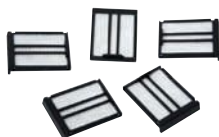

EAK0253B02A Replacement Air Filters (5 pack).

- Help to keep VERUS electronic components cool and clean



EAK0294B08A Maintenance Kit.

- Includes 3 screen protectors, 3 nylon touchscreen stylus and 5 air filters



EAC0101L69A1 Screen Protector Film (3 pack).

- Crystal clear sheets protect screen from scratches, solvents and dirt
- Easy peel and stick application

VERDICT™



EAA0365L01A



EAA0365L03A



EAA0365L06A

VERDICT Accessories

EAA0365L01A Docking Station.

- Convenient and secure charging station for the VERDICT Diagnostic System
- Keep the VERDICT Diagnostic System powered up and charged up all day long
- Uses standard power adapter included with VERDICT Diagnostic System
- USB hub to connect up to 4 USB devices
- 15 pin video connector displays VERDICT results on external big screen monitors
- Multiposition stand, as an angled folding stand, laid flat to fit in tool storage drawer or in a vertical orientation
- LED indicates when docking station is receiving power
- Simple drop-in docking for fast grab and go portability

EAA0365L03A Battery Pack.

- Removable battery pack for fresh power in a snap
- Keep VERDICT Diagnostic System on-duty all day long with a spare battery pack
- Calibrated power meter on VERDICT toolbar shows state of charge
- Multicell battery pack provides up to 4 hours of nonstop use
- Li-ion battery cells for long charge life, long cycle life and quick recharge

EAC0107L03A5 Screen Protector Sheets.

- Includes 3 removable screen protector sheets
- Easy peel and stick application
- Simply peel off old protector sheet and press on a new one
- Help to keep VERDICT touchscreen clean and protected
- Helps maintain touchscreen sensitivity
- Protects screen from scratches, solvents and dirt
- Crystal clear protection for optimum viewing inside the shop or outside in the sun

EAA0365L06A Battery Pack.

- Extended charge life battery pack
- Work longer without a recharge; 6 cell battery offers twice the charge life of standard 3 cell VERDICT battery
- Up to 8 hours of nonstop use with VERDICT D7 Display
- No extra bulk, fits in the standard VERDICT battery slot
- Removable battery pack for fresh power in a snap
- Keep VERDICT Diagnostic System on duty all day long with a spare battery
- Calibrated power meter on VERDICT toolbar shows state of charge
- Li-ion battery cells for long charge life, long cycle life and quick recharge



2-02839A AC Power Supply with Cord.

- For VERDICT D7 display (standard with VERDICT diagnostic unit)



EAK0301L01A1 AC Power Supply with Cord.

- For VERDICT M2 meter (standard with VERDICT diagnostic unit)



EAK0301L03A Replacement Scope/Meter Test Leads.

- With alligator clip set (standard with VERDICT diagnostic unit)



EEMS324PSA Pressure Transducer Adaptor.

- Adapts VERDICT M2 meter to EEPV302AL, EEPV302AT and EEPV302AH pressure transducers (not included)



WARNING



- Do not use in environment with explosive vapor
- Read safety precaution on pages W1 to W4

DIAGNOSTICS

Accessories

SOLUS Ultra®



SOLUS ULTRA Accessories

EAC0111L40A3 Screen Guards.

- Includes 3 removable screen protector sheets
- Simply peel off old protector sheet and press on a new one
- Helps maintain touchscreen sensitivity
- Protects screen from scratches, solvents and dirt for a clear view



EAX0068L10A Extended Length OBD-II Data Cable.

- Extend your diagnostic range and mobility with 9' OBD-II data cable



2-04650A SOLUS Ultra Spare Battery.

Protective Skin

- Soft, sturdy and flexible thermoplastic rubber
- Protects *SOLUS Ultra* diagnostic unit from dirt, grease and other automotive fluids; keep your tool looking like new
- Give *SOLUS Ultra* diagnostic unit a personal touch with your choice of colors
- Forms a nonslip grip over outside of your *SOLUS Ultra* platform
- Designed with access openings for screen, connectors and cooling vents for unimpeded operation

EAC0111L50A1 - Black

EAC0111L50A2 - Red



2-35466A 110 V AC Power Supply.

- Quick charges battery pack (power cord sold separately)



6-06321A AC Line Cord.

- Power cord for 110 V power supply

SOLUS PRO™



EAA0352L35A Replacement Display Window.

- Keep the display looking new and easy to see
- Easy snapfit replacement



Protective Skin

- Personalize and protect your *SOLUS PRO* diagnostic unit with custom fit, nonslip rubber skin

EAC0098L01A1 - Black

EAC0098L01A2 - Red

EAK0290L10A Screen Protector Film (5 pack).

- Crystal clear sheets protect screen from scratches, solvents and dirt
- Easy peel and stick application (*SOLUS PRO* diagnostic unit shown not included)



EAK0276B02A 110 V AC Power Supply.

- Provides power and quick charge battery pack



EETM303A01 Spare Battery Pack for SOLUS PRO.

- Keep a spare, high energy NiMH battery charged and ready to go

ETHOS®



EAC0093L01A Replacement ETHOS Data Cable.

- Replacement data cable for global OBD-II applications



EAC0089L07A Replacement ETHOS DB25/DB15 Adaptor Cable.

- Replacement data cable for OBD-I and OBD-II VIN specific applications



EAK0287L03A Replacement Display Window.

- Keep the display looking new and easy to see
- Easy snap fit replacement

EAK0287L04A Screen Protector Film (5 pack).

- Crystal clear sheets protect screen from scratches, solvents and dirt
- Easy peel and stick application (*ETHOS* diagnostic unit shown not included)



EAK0287L05D ETHOS Extended Adaptor Set.

- Optional OBD-II connectors for VIN specific U.S. and Asian vehicle applications



EAK0276L10A Replacement Display Window.

- Keep the display looking new and easy to see
- Easy snapfit replacement



EAK0276L11A Screen Protector Film (5 pack).

- Crystal clear sheets protect screen from scratches, solvents and dirt
- Easy peel and stick application (*Vantage PRO* diagnostic unit shown not included)



EAK0276B02A 110 V AC Power Supply.

- Provides power and quick charge battery pack



EETM303A01 Spare Battery Pack for *Vantage PRO*.

- Keep a spare, high energy NiMH battery charged and ready to go



WARNING



- Do not use in environment with explosive vapor
- Read safety precaution on pages W1 to W4

DIAGNOSTICS

Accessories



2-35466A 110 V AC Power Supply.
Adaptor powers *MODIS* and quick charges battery pack (power cord sold separately).



6-06321A AC Cord for 110 V Power Supply. Line cord for AC power adaptor.



EEMS301A01 *MODIS* Battery Pack. Keep *MODIS* on duty all day long with a spare high energy NiMH battery charged and ready to go.

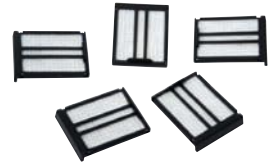

EAK0253B02A Replacement Air Filters (5 pack). Helps to keep *MODIS* electronic components cool and clean.



Screen Protector Film (5 pack)
Crystal clear sheets protect screen from scratches, solvents and dirt. Easy peel and stick application.
EAK0253B20A - Pre-2006 *MODIS*
EAK0253L62A - 2006-later (with removable window)
(*MODIS* diagnostic unit shown not included)



EEMS301A02 External Battery Charger with 110 V AC Converter.

- Faster, cooler charge for long battery life
- Keep a spare battery on charge, ready for action
- Includes 110 V AC power supply and cord.

Service Banners

Service Banners

2 H x 8 W.

Show your customers that the shop is well equipped and qualified with these sturdy reinforced vinyl banners.

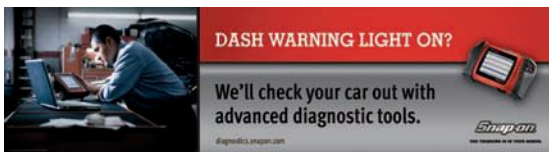

EAZ0003B58B *MODIS* Banner



EAZ0003B66A *MODIS* Banner (Spanish)



EAZ0042B17A ShopKey® Banner



EAZ0063L28A *VERDICT*™ Service Banner



EAZ0060L19A *SOLUS PRO* Banner (Spanish)



EAZ0042B18A *VERUS*™ Banner



EAZ0075L22A *SOLUS Ultra*® Banner

Scan Tool Accessories: Specific Applications Listed Below



EAA0355L46C Replacement OBD-II Key Adaptor.

- For U.S. and Asian vehicle applications
- Accepts "K" personality keys
- Fits VERUS®, MODIS™ and SOLUS PRO™ diagnostic units



EAX0066L50A Replacement Data Cable.

- For connection between scan tool and vehicle adaptors
- For VERUS, MODIS, SOLUS PRO and SOLUS Ultra® diagnostic units only



EAX0066L30A OBD Data Cable Extension.

- Extend scan tool reach by 6'
- Fits VERUS, MODIS, SOLUS PRO and ETHOS® diagnostic units



EAA0355L68A DL-16 Key Adaptor-European Vehicles.

- Replacement adaptor for European vehicle applications
- Accepts "S" personality keys
- Fits VERUS, MODIS, SOLUS PRO and ETHOS diagnostic units

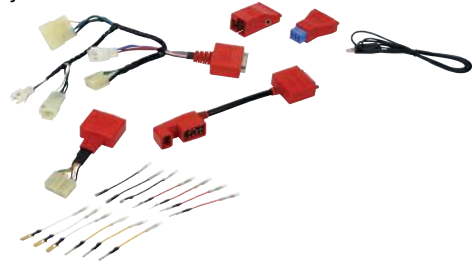

EAK0288B04B OBD-I Vehicle Adaptor Kit 2.

- For U.S. and Asian applications
- Includes: Chrysler1, Chrysler2, Multi2, Jeep1, Hyundai2 adaptors, ground leads and jumper leads
- Fits VERUS, VERUS Wireless, VERDICT™, SOLUS PRO, SOLUS Ultra, MODIS and ETHOS diagnostic units



European Vehicle Adaptor Kit

EAK0301B07B

- Fits VERUS Wireless, VERDICT, SOLUS Ultra diagnostic units

EAK0267B01H

- Fits VERUS, MODIS, SOLUS PRO, ETHOS diagnostic units
- European vehicle adaptor kit
- Includes VW1, MB1, MB2A, BM1B adaptors (includes keys where applicable)
- Requires European Vehicle Software Activation
- Covers the most popular 1992-newer European vehicles

EAK0294B34A Key Kit for Land Rover® vehicles.

- Set of personality keys required for complete Land Rover coverage with VERUS, MODIS, SOLUS PRO and ETHOS diagnostic units



EAK0301B08A OBD-I Vehicle Adaptor Kit 1.

- OBD-I vehicle adaptor kit includes the most U.S. and Asian vehicles
- Kit includes data cable and the: Multi1, Ford1B, Ford4, TMM1, Toyota1, Toyota2, Nissan1, Nissan2, Mazda1, Honda1, Mitsubishi1 adaptors
- Optional for VERDICT and SOLUS Ultra



EAX0068L01A Replacement Data Cable for OBD-I and European Adaptor Applications.

- Fits VERUS Wireless, VERDICT and SOLUS Ultra diagnostic units



EAX0068L00B Replacement OBD-II Data Cable.

- Fits VERUS Wireless, VERDICT and SOLUS Ultra diagnostic units



WARNING



- Do not use in environment with explosive vapor
- Read safety precaution on pages W1 to W4

DIAGNOSTICS

Scope & Meter Accessories: VERUS®, VERUS Wireless, MODIS™ & Vantage PRO™ only



- Pressure Transducer Kits.**
- Record, plot and monitor pressure in real time
 - Typical applications include ABS, PS, transmissions, hydraulics and fuel systems
 - VERUS, Vantage PRO and MODIS require EEMS301A05
 - VERDICT requires EEMS324PSA
 - EEPV302AL** - 0-100 psi
 - EEPV302AT** - 0-500 psi
 - EEPV302AH** - 0-5000 psi



- EAX0024B40A Transducer Y Adaptor Cable.**
- Enables simultaneous use of 2 pressure transducers for multiple point comparison testing



- EETA108B Extra Long Scope Lead Set (2 pack).**
- 10' leads extend the reach of scope/meter leads for testing hard to reach components



- EETA308D Low AMP Probe.**
- Hall effect technology gives accurate nonintrusive circuit testing
 - Perform precision testing of parasitic draw, injectors, pumps, relays, and more
 - 20/60 A ranges



- EEMS301A05 Split Lead Adaptor.**
- Enables simultaneous use of 2 pressure transducers and rpm pickup
 - Fits VERUS, VERUS Wireless, Vantage PRO and MODIS



- EESX306A Waveform Demonstration Tool.**
- Versatile scope training/demo tool
 - Use with any scope
 - Simulates good waveforms, bad waveforms and glitches
 - Square wave, variable duty, FI pattern, AC signal, secondary ignition pattern
 - Adjustable frequency, voltage, rpm and amplitude

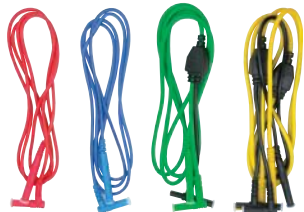

- Test Leads.**
- Shielded, soft, flexible leads for meter and scope measurement
 - Stackable, right angle ground plug attached
 - 6-03022A** - Channel-1 (Yellow)
 - 6-03122A** - Channel-2 (Green)
 - 6-03222A** - Channel-3 (Blue)
 - 6-03322A** - Channel-4 (Red)



- Alligator Clips.**
- Spring loaded clips provide secure, insulated connection for meter and scope measurements
 - 2-06433A1** - Black
 - 2-06433A2** - Red
 - 2-06433A3** - Blue
 - 2-06433A4** - Yellow
 - 2-06433A5** - Green



- MT3000430ASR Backprobe Adaptors.**
- Used for adapting wire harness terminals to alligator clip type test leads
 - Helps prevent accidental grounding



- EAX0024B30A 6' Transducer Cable Extension.**
- Extends the reach of EEPV302AL/AT/AH pressure transducers by 6'

Scope & Meter Accessories: VERUS®, VERUS Wireless, MODIST™ & Vantage PRO™ only



Multi-cylinder Secondary Ignition Scope Adaptors

Exclusive kV ignition adaptors make for easy connection and testing of secondary ignition on coil-on-plug (COP) and coil-in-cap (CIC) systems. Custom fit to vehicle ignition systems. Requires EAK0294B09A ignition scope lead kit.

EAC0056L00A General-purpose COP/CIC Single Flag Pick-up. Single cylinder pickup. Use with 3 flag pickup for V8 engines.

EAC0056L02A General-purpose COP/CIC Three Flag Pick-up. 3 cylinder pickup. Use 2 for V6 engines or use 2 with single cylinder pickup for V8 engines.

EAC0056L03A General-purpose COP/CIC Stick Pick-up. For inline 4 cylinder engines.

EETM306A03 COP-1 Ignition Pick-up for Ford® Vehicles.

EETM306A04 COP-2 Ignition Pick-up for Chrysler® Vehicles.

EETM306A07 COP-3 Ignition Pick-up for VW®/Audi® Vehicles.

EETM306A08 COP-4 Ignition Pick-up for Acura®/Honda®/Isuzu® Vehicles.

EETM306A09 COP-5 Ignition Pick-up for Volvo®/BMW® Vehicles.

EETM306A10 COP-6 Ignition Pick-up for Mercedes® Vehicles.

EETM306A11 COP-7 Ignition Pick-up for Mercedes Vehicles.

EETM306A12 COP-8 Ignition Pick-up for BMW Vehicles.

EETM306A13 COP-9 Ignition Pick-up for Lexus® Vehicles.

EETM306A14 COP-11 Ignition Pick-up for Chrysler/Jeep®/Lexus/Toyota® Vehicles.

EETM306A06 CIC-1 HEI CIC Pick-up for GM® Vehicles.

EETM306A05 CIC-2 CIC Pick-up for Toyota/Honda Vehicles.



EAK0294B09A Ignition Scope Lead Kit.

- For multicylinder secondary ignition testing
- Includes inductive rpm pickup trigger, coil adaptor lead and secondary kV clip on probe
- Ideal for distributor systems, and for COP/CIC systems using optional COP/CIC adaptors

EETA309A15 SIA 2000 Multi Ignition Adaptor.

- Ideal for waste spark ignition systems up to 8 cylinders
- Simply clamps directly to plug wires
- Also for COP/CIC systems (COP/CIC adaptors sold separately)



WARNING



- Do not use in environment with explosive vapor
- Read safety precautions on pages W1 to W4

DIAGNOSTICS

5-Gas Analyzer: VERUS®, MODIS™ or PC



EEEE305A

EEEE305A FGA Flexible Gas Analyzer.

- Completely portable 5-T_{ms} Analyzer with rechargeable internal battery
- Exhaust gas analysis helps pinpoint engine, emissions, catalytic converter and related system problems
- Live graphing and digital display of CO, O₂, CO₂, HC, NO_x, Air/Fuel ratio and Lambda
- Heavy duty sensors with automatic water removal system
- Includes probe, hose, power adaptors and RS-232 cable
- VERUS and PC applications also require EEEA305ASW software sold separately

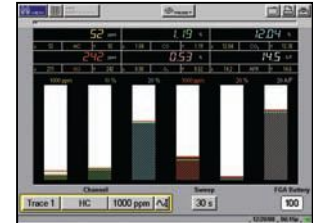

HHGA5A

Hand Held Gas Analyzer

HHGA5A Hand Held Gas Analyzer Kit (5 Gas).

- Fully portable 5-T_{ms} Analyzer goes anywhere, can be used anywhere
- 110 V AC and 12 V DC powered
- The internal rechargeable battery provides up to 1 hour use
- Ideal for road testing and mobile use
- Measures exhaust emissions for CO, CO₂, HC, O₂, NO_x and AFR/Lambda
- Provides an instant assessment of an engine vehicle exhaust and catalytic converter
- MODIS, VERDICT™ and VERUS Link for enhanced real time viewing
- Add a 5-T_{ms} Analyzer function to MODIS, VERUS and VERDICT
- Set up required with included software on USB stick
- Gather all the evidence required for effective and accurate vehicle diagnostics on one screen in real time
- T_{ms} Analysis

- Component tests
- Scope readings
- Digital graphing function
- Scanner results
- View, graph, save and recall data
- Monitor and reduce vehicle emissions; improve driveability and fuel efficiency
- Truly handheld about the size and weight of a DMM offering true portability
- Compatible with gasoline, CN™, propane and diesel fuel types
- Very sensitive and pulls only 1/14th the exhaust volume of competing analyzers. This means no problems with water ingress and pumps last longer

TECHNICAL SUPPORT
1-888-717-1333

Custom Fit Foam Organizers

- Turn a tool cart into a high power mobile workstation
- Set of drawer organizers holds diagnostic platform and all standard accessories, plus room for many optional accessories

Drawer organizers to fit roll carts KRSC30, KRSC31, KRSC33 and KRSC326:

- VERUSFOAM3** Foam drawer organization for VERUS® and adaptors.
- VERUSWFOAM3** Foam drawer organization for VERUS Wireless and adaptors.
- VERDICTFOAM3** Foam drawer organization for VERDICT™ and adaptors.
- MODISFOAM3** Foam drawer organization for MODIS™ and adaptors.
- SOLUSVPFOAM** Foam drawer organization for SOLUS PRO™ and Vantage PRO™ and adaptors.
- SOLUSUFOAM3** Foam drawer organization for SOLUS Ultra® and Vantage PRO and adaptors.



KRSC40 cart sold separately. Tools not included.

Drawer organizers to fit roll carts KRSC40, KRSC42 and KRSC46:

- VERUSFOAM4** Foam drawer organization for VERUS and adaptors.
- VERUSWFOAM4** Foam drawer organization for VERUS Wireless and adaptors.
- VERDICTFOAM4** Foam drawer organization for VERDICT and adaptors.
- MODISFOAM4** Foam drawer organization for MODIS and adaptors.
- SOLUSUFOAM4** Foam drawer organization for SOLUS Ultra and Vantage PRO and adaptors.



VERUSFOAM4



EAK0294B04A

EAK0294B04A - Leather Travel Case.

- Ultimate in portability and protection
- Multiple zippered compartments to organize diagnostic platform and accessories
- Handle and sturdy nylon shoulder strap for easy portability
- For VERUS, VERDICT, SOLUS PRO, SOLUS Ultra, Vantage PRO and ETHOS® diagnostic units (not included)



EAK0294B17A

EAK0294B17A - Low Profile Organizer Case.

- Protect and organize your diagnostic tool and accessories for easy storage and portability
- Includes foam inserts to fit VERUS, MODIS, SOLUS PRO or SOLUS Ultra (diagnostic tool not included)
- Custom fit foam organizer for standard accessories; adaptors, cables, battery, charger, etc.
- Textured fabric exterior with semi rigid shell case
- Padded handle and shoulder strap included
- Low profile to fit in toolbox drawer 5.5" D x 14" W x 25" L



WARNING



• Read safety precautions on pages W1 to W4

DIAGNOSTICS

Software and Information Systems

Diagnostic Software Upgrades - for VERUS®, VERUS Wireless, VERDICT™, MODIS™, SOLUS PRO™, SOLUS Ultra®, Vantage PRO™ and ETHOS®

- Continue to improve your productivity with regularly scheduled software upgrades from Snap-on featuring updated coverage for new vehicles, expanded coverage for earlier models and the latest enhancements that add capabilities to your tool
- You'll access thousands of new vehicle systems, trouble codes and live data parameters, as well as thousands of new experience based troubleshooter tips, functional tests, adaptations and component tests for platforms with those functions
- For details on the latest software upgrade, see your Snap-on representative

European Vehicle Activation for VERUS, VERUS Wireless, VERDICT, MODIS, SOLUS PRO, SOLUS Ultra and ETHOS

- Comprehensive OEM specific coverage is critical for servicing European makes, from fault codes and data for dozens of vehicle systems, to functional tests, relearns and adaptations for vehicles with those features
- Coverage for Audi®, BMW®, Land Rover®, Mercedes®, MINI®, SMART®, Volvo® and Volkswagen® vehicles as far back as 1992
- See your Snap-on representative



EETA113B Pass Thru Pro II.

- Reprogram vehicle control modules like the OEMs
- Updates software/firmware in vehicle electronic control units (ECU)
- For J2534 compliant 2004-later vehicles
- Includes OEM approved programming interface, cables and software
- Requires internet access, OEM data subscription or a PC



ShopKey Repair Information System ShopKey Medium Truck ShopKey Tractor-Trailer and REPAIR>CONNECT ShopKey Service Writer/Shop Management

- The most trusted source of automotive repair information available, ShopKey is loaded with features to make you more efficient and your repair job easier
- Access tools such as ShopKey live tips, enhanced TSB's, the industry's only scalable vector graphic color wiring diagrams and vintage information dating back to 1960
- With ShopKey online access you're always up to date on the latest vehicle coverage and industry changes
- Whether it's repair and estimating for Light Duty vehicles, Medium Truck, Tractor-Trailer, Service Writer or Shop Management software you're looking for, ShopKey has you covered
- Access ShopKey on your Snap-on® VERDICT, VERUS or VERUS Wireless platform and you'll never have to leave the service bay again to access the information you need to get the job done
- For details on how to make ShopKey a part of your daily diagnostic and repair routine, see your Snap-on representative or visit diagnostics.snapon.com/shopkey

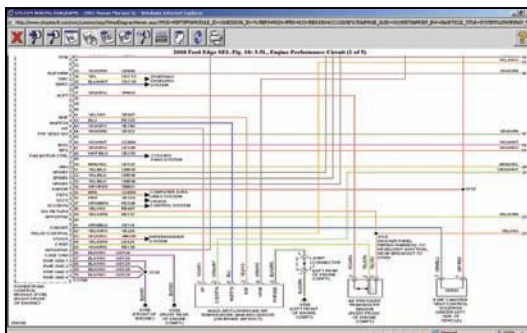

Full color OEM wiring diagrams simplify even the most difficult procedures.

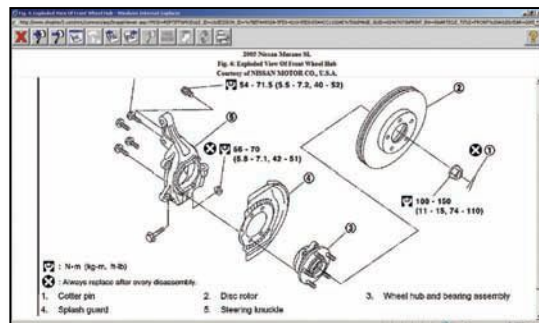

Become an instant expert on millions of different repairs.

EESC717PRO MICROSCAN® Pro (Blue-Point®) Global OBD-II Scanner.

- With internal battery power and automatic code display in as little as 10 seconds
- Covers all 10 modes of OBD-II
- Codes, live data, experience based code tips and timesavers for a confident diagnosis
- Easy Y/N buttons and icon shortcuts for frequently used functions
- 2 PID graphing to compare two live data streams side by side
- Big 7 line backlit display shows easy to read results and complete code definitions in plain language
- Exclusive code tips point to common causes and get to the root cause of a trouble code faster
- Record and playback 64 point data files
- Save vehicle ID and diagnostic results for 25 vehicles
- Enhanced engine codes for complete driveability diagnostics on M®, Ford®, Chrysler® vehicles
- ABS brake system codes for GM, Ford and Chrysler vehicles
- OBD-I coverage for GM, Ford, Chrysler, and select Toyota® vehicles (requires optional EAK0302L01A adaptor kit)



MICROSCAN Accessories

EAK0302L01A MICROSCAN (Blue-Point) OBD-1 Adaptor Kit.

- Connect MICROSCAN PRO to pre-1996 GM, Ford, Chrysler and Toyota vehicles

Note: For MICROSCAN PRO scanner only. Not applicable to Snap-on® brand scan tools

8-07324A MICROSCAN (Blue-Point) Travel Bag.

- Padded nylon soft case, custom fit for MICROSCAN scanner
- Keeps MICROSCAN scanner and all standard accessories organized and protected

EAC0106L18A MICROSCAN (Blue-Point) Custom Fit Silicon Skin.

- Keeps MICROSCAN scanner clean and protected from grease, solvents and dirt
- Comfortable, cushioned nonslip silicone rubber

Car Reader Scan Tools

EECR1 CarScan-Reader.

- Works on new 2010 Diesel emissions systems and Hybrids
- Backlit display
- Vehicle Health Status LEDs confirm if a vehicle will pass or fail an emissions/ smog test
- Mini USB

EECR2 CarScan-Diagnostics.

- Plug and play diagnostics
- ABS DTCs
- Internal batteries, on screen DTC library in English and Spanish
- USB and software are included
- Freeze frame data and manufacturer specific definitions
- Mini USB

TECHNICAL SUPPORT

1-877-447-6276

	Description	EECR1	EECR2
Application	Diagnostic Check Engine Lights on 1996 and Newer Vehicles	•	•
	Turns off Check Engine Light	•	•
Unique Features	Works on Late Model Vehicles with CAN Protocol	•	•
	Plug and Play Diagnostics with All in One Display	•	•
	Vehicle Health Status LED Display	•	•
	OBID Emissions Readiness	•	•
	Hot Keys for Intuitive Navigation	•	•
	Complete Drive Cycles with Emissions Readiness Advisor	•	•
	Automatic Vehicle Identification	•	•
	Trilingual Display		•
	Battery Backup for off Vehicle Review		•
Backlit Display		•	
On Board Diagnostic Features	Retrieves Manufacturer and Generic Codes	•	•
	Displays Enhanced Freeze Frame Data		•
Bonus Features	On Screen Code Definitions in English, French or Spanish		•
	Create Vehicle Diagnostic Reports		•
	Internet Updateable, Software and Cable Included		•



EECR1

EECR2



WARNING



• Read safety precautions on pages W1 to W4

DIAGNOSTICS

iQ™ Heavy Duty Scan Tools



TECHNICAL SUPPORT
1-800-639-6774



EEHD188001 Pro-Link® iQ Kit.

Smarter. Easier. Essential. The recognized standard in diagnostic scan tools.

Pro-Link iQ kit is designed to help diagnose engine, brake and transmission failures. This easy to use, advanced tool is engineered to support today's commercial vehicles as well as the more complex vehicles of tomorrow. Using clear menus and message screens, the *Pro-Link iQ* kit guides technicians through the most complicated vehicle tests.

Key Functions and Features:

- Large, sharp color graphics
- Information clearly displayed
- Fast data downloads
- Portable and powerful

Kit Includes:

Pro-Link iQ Scan Tool.

EEHD889008 *iQ* Heavy Duty Standard Application.

EEHD501002 Power and Data Cable.

EEHD488099 Power Supply.

EEHD488024 6 Pin Deutsch Adaptor.

EEHD488028 9 Pin Deutsch Adaptor.

EEHD4001018 2 Cell Battery Pack.

EEHD850089 CD Manual/Driver.

EEHD1402813 Stylus Pen (1 in kit).

EEHD210007 Carrying Case.

EEHD889008 Heavy Duty

Standard J1939*.

EEHD888076 OBD II Software*.

EEHD481013 OBD II/J1962

Adaptor*.

EEHD909008 Fault Code Guide*.



EEHD181030S Pocket iQ Scan Tool (Blue-Point®).

The quick and convenient way to gather critical truck performance data.

Whether covering a large fleet or monitoring just a truck or 2, the compact *Pocket iQ* scan tool makes it easy to collect operating information. With its advanced capabilities, touchscreen technology and clear message and menu screens, the *Pocket iQ* scan tool reports critical engine, brake and transmission functions. It also stores and accesses vital facts and figures, fault codes and more.

Key Functions and Features:

- Monitors all vehicle data
- Checks engine speed and load, pressures, temperatures and more
- Reads active fault codes
- Reads and clears inactive fault codes
- Displays trip data
- Collects and stores data from multiple vehicles
- Stores data in PDF or text format
- Supports J1708 and J1939 communication
- Supports OBD-II communication*

Kit Includes:

EEHD501002 Power and Data Cable.

EEHD488024 6 Pin Deutsch Adaptor.

EEHD488028 9 Pin Deutsch Adaptor.

EEHD481013 OBD II/J1962 Adaptor*.

EEHD403098 USB Cable.

EEHD181030-2 Battery Pack.

EEHD181030PB Soft Storage Case.

EEHD1402813 Stylus Pen (1 in kit).

SS3241 Instructional DVD*.

EAK0276B02A AC Power Adaptor.

*Included exclusively in the Snap-on® and Blue-Point versions.

EEHD681004 Extreme Heavy Duty Pro-Link® iQ Kit. Smarter. Easier. Essential. The recognized standard in diagnostic scan tools.

This kit includes all current available software for diagnostics, the most common adaptors, the fault code guide, and includes the hardened case to protect your investment.

Key Functions and Features:

- Large, sharp color graphics
- Information clearly displayed
- Fast data downloads
- Portable and powerful
- 1 Year Warranty

Accessories Included:

- EEHD481009 HD/1962 GM® Truck for GM Truck CAT® Engine Adaptor.
- EEHD481003 12 Pin Connector*.
- EEHD909008 Heavy Duty Fault Code Guide*.
- EEHD219006 Extreme Heavy Duty Case*.
- EEHD219006-1 Foam*.

Kit Includes:

- EEHD188001 Pro-Link iQ Scan Tool.
- EEHD889008 J1939 Heavy Duty Standard**.
- EEHD888008 J1708/J1587 Heavy Duty Standard**.
- EEHD888076 OBD-II for Light and Medium Trucks.
- EEHD501002 Power and Data Cable.
- EEHD488099 110 V Power Adaptor.
- EEHD488028 9 Pin Deutsch Adaptor.
- EEHD488024 6 Pin Deutsch Adaptor.
- EEHD481013 OBD-II/J1962 Adaptor.
- EEHD4001018 2 Cell Battery Pack.
- EEHD1402813 Stylus Pen (1 in kit).
- EEHD850089 CD Manual/Drivers.

* Cummins® support for these applications limited to basic codes and data

** New to the Extreme Kit. (Not in the old RWD Master Kit).

TECHNICAL SUPPORT
1-800-639-6774



- Software Included: EEHD681004
- EEHD889015 For DDEC VI Software (2007-2009) for Detroit Diesel® Electronic Systems.
 - EEHD888015 For DDEC Software Suite - DDEC III, IV and V (1995-2006) for Detroit Diesel Electronic Controls.
 - EEHD889031 For Detroit Diesel MBE Engines (Pre-EPA07).
 - EEHD880024 For Caterpillar® ACERT® 2.0 (2003-2009) for Diesel Engines.
 - EEHD889024 For CAT Electronic Engines (1990-2003).
 - EEHD888005 Allison® Software Suite - GEN IV, 1K/2K, 3K/4K, CEC1 for Allison Engines.
 - EEHD888014 WABCO Suite for Air and Hydraulic Diagnostic Systems.
 - EEHD881048 LMT Software - Enhanced for Ford®, GM and Isuzu® Vehicles.
 - EEHD880010 International® Engines Software 2.0 (1994-2006) for International Engines**.
 - EEHD881009 For Navistar® MaxxForce® (2007-2009) Diesel Engines**.

Engines

Detroit Diesel Engine Applications

- EEHD889015 DDEC VI/MBE Software (2007-2009) for Detroit Diesel Engines.
- EEHD888015 DDEC Suite III, IV, V Software (1995-2006) for Detroit Diesel Engines.
- EEHD889031 DDEC MBE Software (2001-2006) for Detroit Diesel Engines.
- EEHD481003 12 Pin Adaptor, DDEC I & II for GM Engines.

International-Navistar Engine Applications

- EEHD881009 For Navistar MaxxForce (2007-2009) Diesel Engines.
- EEHD880010 International Engines Software v2.0 (1994-2006) for International Engines.
- EEHD880010U International Engines Software v2.0 Upgrade (1994-2006) for International Engines.

Caterpillar Engine Applications

- EEHD880024 Caterpillar ACERT Software v2.0 (2003-2009) for Caterpillar Engines.
- EEHD880024U Caterpillar ACERT Software v2.0 Upgrade (2003-2009) for Caterpillar Engines.
- EEHD889024 For Caterpillar Engines (1990-2003).
- EEHD401015 9 Pin for Caterpillar Deutsch Engines (1990-1995). Required.
- EEHD401014 9 Pin for Caterpillar T Engines (1990-1993).

Mack®, Volvo®, Cummins and Other Applications

Snap-on is pleased to offer the Heavy Duty Standard application for use with Mack, Volvo, Cummins and other engines.



WARNING



• Read safety precautions on pages W1 to W4

iQ Software

Transmissions

Heavy Duty Transmission Applications

Heavy Duty Transmission applications allow viewing of proprietary information and the running of tests.

- EEHD888005 Allison Transmission Suite GEN IV, 1K/2K, WTEC, CEC1.



Brakes

Heavy Duty ABS Applications

Heavy Duty ABS applications provide diagnostic ABS information for both tractors and trailers. Allow viewing of proprietary information and running of special tests.

- EEHD888014 Meritor WABCO Air and Hydraulic Diagnostic Systems.
- EEHD889013 For Bendix Air ABS Brake Systems.
- EEHD601020 PLC Converter Kit (2002-Current) for ABS Powerline Carriers.

Required for newer trailers.



EEHD601020

DIAGNOSTICS

Heavy Duty Vehicle Diagnostics

Light and Medium Truck (LMT) Applications

EEHD881048 Light/Medium Duty Trucks for Ford®, GM® and Isuzu® (2001-2010) vehicles.

EEHD881048U Light/Medium Duty Trucks for Ford, GM and Isuzu Upgrade (2001-2010) vehicles.

EEHD888076 For Light/Medium Duty Trucks (1996-2011) OBDII Scanner.

Enhanced coverage for gas and diesel engines, including the following:

- Ford**
- 7.3 Liter Powerstroke
 - 6.4 Liter Powerstroke
 - 6.0 Liter Powerstroke

Transmission and ABS coverage:

Ford Brakes and Transmission

- F250-F750
- E250-E450

GM and Isuzu

- 8.1 Liter
- 6.6 Liter Duramax
- 7.8 Liter Diesel
- 5.2 Liter Diesel

GM Brakes and Transmission

- C1500-C7500
- T4500-T7500
- P chassis
- Workhorse

Isuzu Brakes and Transmission

- NPR/NF3
- NQR/NRR



Heavy Duty Standard Applications

Snap-on offers Heavy Duty Standard (HDS) generic applications covering engines, transmissions and brakes that provide access to limited, nonproprietary diagnostic information. HDS capabilities:

- Read active fault codes
- Read and clear inactive fault codes
- View nonproprietary parameters
- Read trip information

EEHD889008 Medium/Heavy Duty Standard J1939 (2004-Current).

Heavy Duty Standard J1708.

Medium/Heavy Duty Trucks 1989-2009 Included.

Pro-Link iQ™ Cables and Accessories



EEHD488024
6 Pin Deutsch Adaptor.



EEHD488028
9 Pin Deutsch Adaptor.



EEHD481009
HD/J1962.



EEHD481013
OBD II/J1962.



EEHD488099
AC Adaptor.



EEHD1402813
Stylus Pens (3-Pack).



EEHD4001018
2 Cell Battery Pack.



EEHD4001019
4 Cell Battery Pack.



EEHD2450801A
Screen Protector.



EEHD210007
Carrying Case.



EEHD219006
Extreme Carrying Case.



EEHD219006-1
2 pc Protective Foam.



EEHD481003
12 Pin Adaptor.



EEHD401012
8 Pin AMP Adaptor.



EEHD401013
2 Pin Adaptor for
Cummins® Engine.



EEHD401014
T 9 Pin Adaptor for
Caterpillar® Engine.



EEHD401015
9 Pin Deutsch
Adaptor for
Caterpillar Engines.



EEHD401016
9 Pin AMP Adaptor.



EEHD421001
J560 PLC Cable.



EEHD501002
Power and Data Cable.



EEHD501003
Data Cable.



EEHD501004
Power Cable.

TECHNICAL SUPPORT
1-800-639-6774